



A&E Bath and Shower

7300 Sherbrooke St. W.
 Montrea, QC, Canada
 H4B 1R7
 www.aebath.com

Model Modèle: BT-1217-NF

Freestanding bathtub *Baignoire autoportante*

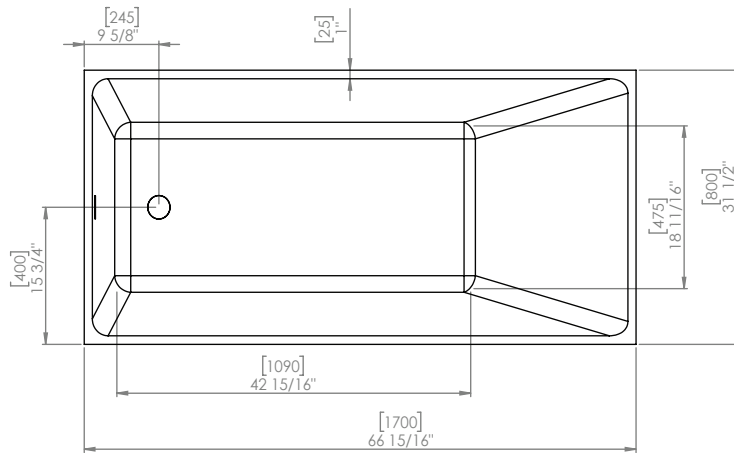

TOP VIEW VUE DE DESSUS

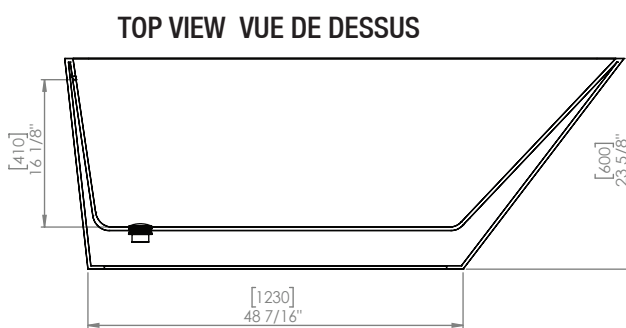
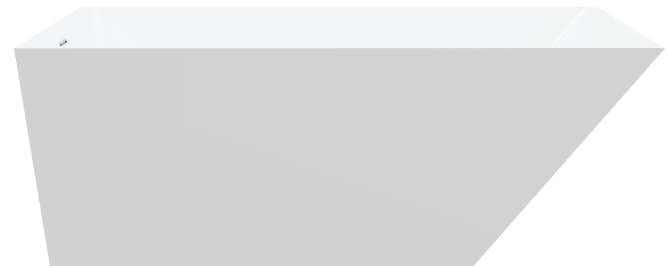

FRONT VIEW VUE DE FACE

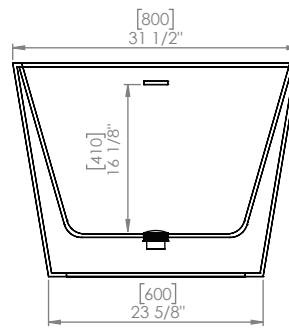

SIDE VIEW VUE DE CÔTÉ

* Dimensions may vary +/- 1/4" (6mm) / Les dimensions peuvent varier de +/- 1/4" (6mm)

gallons to overflow /	87 gal.
packaging dimension /	70 x 34 x 26 in
approximated weight /	141 lbs
weight with water /	865 lbs
bathing well at sump /	43 x 19 in
bathing well at rim /	65 x 30 in



Compliance Certifications:

Uniform Plumbing Code
 National Plumbing Code of Canada
 CSA B45.5-17/IAPMO Z124-2017



Pure acrylic construction reinforced by fiberglass
Construction en acrylique renforcée de fibre de verre

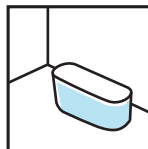

Freestanding installation
Installation autoportante

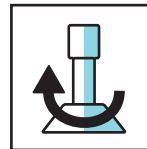

Adjustable feet
Pattes ajustables

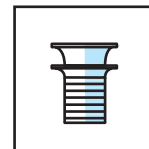

Chrome drain included
Drain chrome inclus

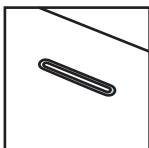

Integrated chrome linear overflow
Trop plein linéaire chrome intégré



CUPC certified
Certifié CUPC